

DuraTech[®]

All-fuel, double-wall
chimney system.

UL 103 HT, UL 103, and ULC S604.



Specifications

Applications

5"-8" DuraTech is a double-wall, all-fuel chimney system for use with wood stoves, fireplaces, furnaces, boilers, ranges, water heaters, or other appliances fueled by wood, oil, coal, or gas, and zero-clearance fireplaces that are factory-built.

Materials and Construction

5"-8" diameter pipe features inner wall of .020" 430 stainless steel. Outer wall options of .016" 430 stainless steel or .021" galvalume steel. A Refractory insulation is encased between walls. Stainless steel end rings seal the pipe.

DuraTech features light weight insulation, twist-lock fittings, support boxes with factory installed starter sections, elbows with 360° swivel base, select black finish pipe lengths, five foot length pipe sections, and adjustable pipe lengths.

Clearances

2" clearance to combustibles.

Shrouds

UL Listed with DuraVent shroud specifications. Information available online at www.duravent.com or call and request L157.

Diameters

5"-8"

Listings

c-UL-us Listed to UL 103 HT and ULC S604 (MH7399)
(Stainless steel outer wall required for oil-burning installations in Canada).



UL 103 HT and ULC S604 System

DuraTech 5"-8"

With a Refractory insulation encased between dual walls, DuraTech offers the optimum in safety and performance. It keeps the outer wall of the chimney cool while ensuring high flue gas temperatures for optimum draft performance.

The inner wall is 25% thicker than competitive chimneys for an extra margin of safety. No locking bands or mechanical fasteners required.

DuraTech's sleek 1" wall design provides for easy installations through 16" on-center framing. For tight installations, a Reduced Clearance Square Ceiling Support Box is available (6" diameter DuraTech only).

Designed for normal, continuous operation at 1000°F flue gas temperatures, DuraTech is subjected to rigorous and stringent high temperature requirements of the UL standard, including one hour at 1400°F, plus three ten-minute chimney fire test at 2100°F.



UL 103 System

DuraTech 10"-24"

DuraVent now offers DuraTech in large diameters to vent large-scale residential fireplaces and building heating appliances.

10"-24" DuraTech chimney is tested and listed for continuous operation at 1000° F flue gas temperatures, one hour at 1400° F and ten-minutes at 1700° F, in accordance with the UL 103 test standard.



Specifications

Applications

10"-24" large diameter DuraTech is a 1" wall, all-fuel chimney system for use with wood stoves, fireplaces, furnaces, boilers, ranges, water heaters, or other appliances fueled by wood, oil, coal, or gas.

Materials and Construction

10"-24" diameter pipe feature .027" 430 stainless steel inner wall and outer wall of .029" galvalume or .027" 430 stainless steel. A Refractory insulation is encased between walls. Stainless steel end rings seal the pipe.

Clearances

2" clearance to combustibles.

Shrouds

UL Listed with DuraVent shroud specifications. Information available online at www.duravent.com or call and request L157.

Diameters

10", 12", 14", 16", 18", 20", 22", and 24".

Listings

c-UL-us Listed to UL 103 and ULC S604 (MH7399)
(Stainless steel outer wall required for installation in Canada.)



Typical Installations For 5"- 24" DuraTech

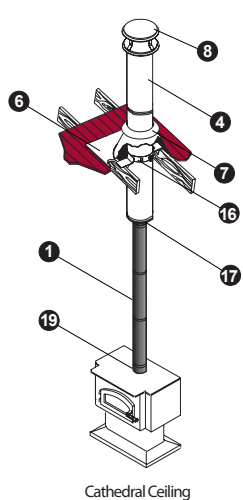

Cathedral Ceiling

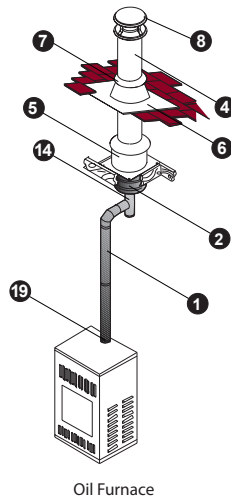

Oil Furnace

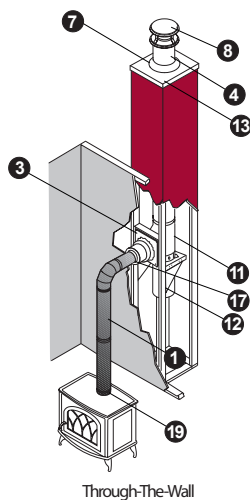

Through-The-Wall

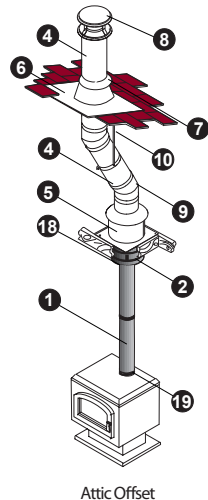

Attic Offset

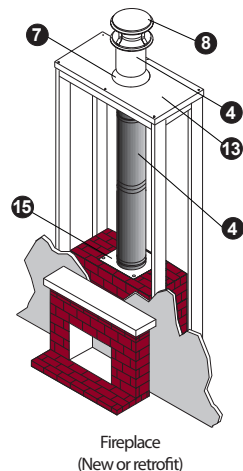

Fireplace
(New or retrofit)

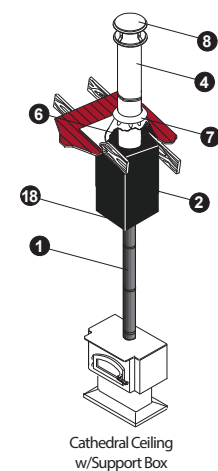

Cathedral Ceiling
w/Support Box

Installation Key

1	DVL or DuraBlack	11	Tee with Tee Cap
2	Ceiling Support	12	Tee Support
3	Wall Thimble	13	Chase Top Flashing
4	Chimney Pipe	14	Base Tee/Double Tee
5	Attic Insulation Shield	15	Anchor Plate or Anchor Plate with Damper
6	Flashing	16	Roof Support
7	Storm Collar	17	Finishing Collar
8	Chimney Cap	18	DVL Adapter, DuraBlack Slip Connector, or Snap-Lock Adapter
9	Elbow	19	DVL Adapter (w/ or w/o damper)
10	Elbow Strap		

Refer to our Typical Installation drawings to select the appropriate component parts for your installation.

- DVL/DuraBlack Chimney Adapter must be used when connecting DVL pipe to a Ceiling Support Box or Finishing Collar. When connecting DuraBlack pipe, a DVL/DuraBlack Chimney Adapter, DuraBlack Slip Connector, or Snap-Lock Adapter must be used.
- Wall Thimble must be installed with an appropriate length of chimney pipe for all horizontal through-the-wall installations. To accommodate thicker walls, the telescoping pieces of the Wall Thimble can be separated, and a field-fabricated extension may be installed.
- Attic Insulation Shield must be used in all installations that pass through an attic, regardless of whether the attic is insulated or not.
- Firestop Radiation Shield must be used when a chimney passes through a floor or ceiling without a support box.

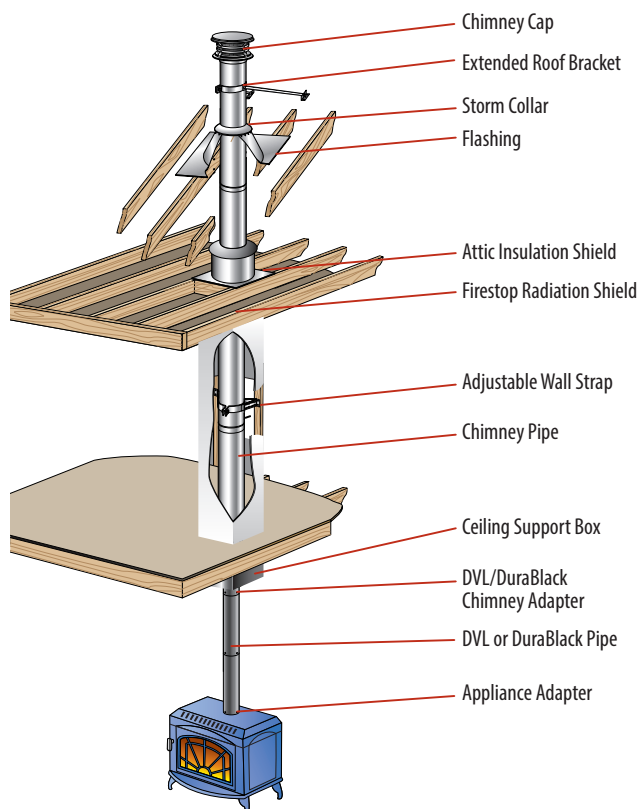

Planning Your Installation

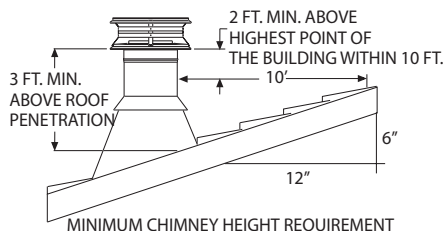

Figure 1

The following recommendations are general guidelines to assist in the layout and selection of the chimney components needed for your installation. Always follow DuraVent Installation instructions before installing your chimney system, found with the cap or support box. Installation instructions can be viewed online at www.duravent.com.

- The diameter of the chimney should match the outlet size of the appliance. An improperly sized chimney results in poor draft and excessive creosote formation.
- Measure the diameter of the appliance flue outlet. Select the chimney and either DVL or DuraBlack connector stovepipe with the same size diameter as the appliance flue outlet. For fireplace installations, refer to the sizing chart in the back of this catalog.
- Determine if the installation is a through-the-roof installation or a through-the-wall installation. A through-the-wall installation will require additional components (Wall Thimble, Tee/ Cap, Tee Support, and Wall Straps).
- Install the chimney in the interior of the structure whenever possible. A cold exterior chimney will produce less draft and will generate more creosote.
- If possible avoid offsets that serve to restrict the natural draft. A straight vertical installation is more efficient and less likely to develop creosote. If an offset is required to avoid rafters or other obstructions, measure the horizontal distance required and the vertical height available. Both 15° and 30° elbows are available. Elbows have a 360° swivel base to allow orientation of elbow direction only. Elbows are fixed at 15° or 30°. Elbows greater than 30° are not allowed in the United States. A maximum of two offsets in a single installation are permitted. Refer to the offset table in the back section of this catalog. At least one Elbow Strap is required for each offset. Elbow Straps ensure adequate support.
- Determine the minimum chimney height above the roof line. Building codes require a minimum of 3' above the roof penetration and at least 2' higher than any portion of a building within 10'. See figure 1. The termination cap is installed above that point. If chimney extends 5' or more above the roof penetration an extended roof bracket is required. An additional roof bracket is needed every 5'.
- Measure the roof pitch. For example a 6/12 pitch has a vertical rise of 6" over a horizontal distance of 12". Select the appropriate flashing.
- Determine the total length of chimney and stovepipe required for the installation. To calculate the installed per length of 5"-8" DuraTech pipe, subtract 1 ¼" per joint. For 10"-24" diameter, subtract ¾" per joint of pipe. Subtract 1 ¼" per joint of DuraBlack stovepipe. Subtract 1 ½" per joint of DVL stovepipe. Minimum chimney height, at sea level, of straight vertical chimney is 10' to 15' above the appliance outlet. Higher elevations, or the use of elbows or a tee, will require approximately 30% to 60% more height to provide for an adequate draft.
- For a UL approved shroud, see the DuraTech Shrouds Installation Instructions (L157). View online at www.duravent.com, under catalogs and instructions.
- Be fire safe. Maintain at least 2" clearance to combustibles. Follow local building codes and have your chimney inspected by a certified professional.

What makes us different from the rest?

DuraTech: The optimum in safety and performance for an all-fuel chimney.



DuraTech Feature	Benefit	DuraTech Feature	Benefit	DuraTech Feature	Benefit
5" through 24" diameter selection	Gives the installer the largest variety of diameters to fit and size the fireplace or stove properly.		Ensures complete insulation coverage between inner and outer walls, preventing any hot spots from appearing due to expansion of the metal walls during operation. Hot spots could cause a fire.	15 and 30 Degree Elbows come with swivel base	The swivel base allows an installer to line up the elbow without unlocking and repositioning the elbow, saving time and money.
6", 9", 12", 18", 24", 36", 48" and 60" pipe lengths	Gives the installer the greatest variety of lengths to reach the desired height with ease and least amount of pipe sections.	1" Refractory Insulation Blanket		15 and 30 Degree Elbows come in kits	This ensures that the installer gets both the offset and return elbow along with an elbow support bracket to make a properly code approved offset.
Twist Lock End Rings	Allows the installer to safely and easily connect and disconnect chimney sections without mechanical fasteners. Encases insulation to prevent exposure to outside elements. No locking bands required.	Factory Installed Starter Section in the Support Box	Allows the installer a safe, quick and easy connection of chimney to the support box.	Limited Lifetime Warranty	The best Warranty in the industry. 15 years 100%, 15 years and up 50%. Gives the installer and home owner the greatest peace of mind in a quality installation.
430 Stainless Steel Inner Wall	Corrosion resistant stainless steel with the smallest amount of expansion when exposed to heat. Prevents hot spots from appearing which could cause a fire.	DuraTech offers 3 support box heights. 12", 24", 36" along with flat and round supports	Gives the installer the most options when dealing with ceiling slopes. Creating the most aesthetically pleasing installation possible.	Adjustable Tee and Wall Support Brackets	Guarantees proper clearance to combustibles, allowing the installer to work around changing exterior wall surfaces, avoiding any field fabrication or code violation.
.020" thick Stainless Steel Inner Wall	Thickest inner wall construction in the industry providing the best protection from creosote fires.	Reduced 10" wide Support Box for 6" diameter DuraTech	Allows for the smallest area of framing while still maintaining safe and approved clearances to combustibles. Could prevent having to reframe around chimney.	Shroud Specifications	Shroud specs allow the installer to create a UL listed shroud to hide the termination at the top of the chase for safest installation.
Light Weight Construction	Light weight Thermo Tech insulation makes pipe sections lighter (5lbs per ft for 6" diameter) to allow the manufacture of 5' lengths, thus the installer has fewer trips up the ladder for a quick and easy installation.	DuraVent offers 3 easy options to attach Connector Pipe to Chimney System with the DVL/DB adapter or the DB slip connector	Allows installer to connect DVL, DuraBlack or stovepipe to the support box or finishing collar for an easy and quick installation. Adapter screws into support box and ensures a firm connection between stovepipe and support box.	Adjustable Height Attic Insulation Shield	Allows the installer to accommodate deep attic insulation without having to field fabricate an extension. Saves time and money.
1" Double Wall Insulated Pipe	Has the smallest outside diameter available to allow easy placement between studs. i.e. 8" O.D. on 6" diameter pipe. Saves from having to reframe around the chimney.			Removable Top Plate and Spark Arrestor on termination cap	Easy cleaning of chimney without having to disconnect and remove the cap. Saves time and money in cleaning.

DuraTech® 5"-8"

Chimney Pipe

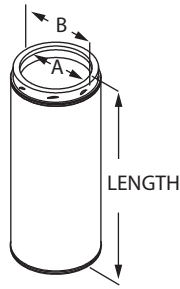

To calculate installed length of 5", 6", 7", or 8" DuraTech Chimney, subtract 1 1/4" from each joint overlap of chimney pipe. Allow a minimum of 2" air space to combustibles when installing DuraTech Chimney.

Note: Short painted Chimney Pipe Sections are available for use in exposed roof support installations.

5" - 8" Diameters - Designed for appliances that are tested and listed for use with a 2100°F HT chimney system, such as wood stoves, fireplaces, furnaces, boilers, ranges, water heaters, or other appliances fueled by wood, oil, coal, or gas. Available in stainless steel (5"-8" SS) or galvalume (6"-8" GA) outer casing and stainless steel inner wall with twist-lock connections. DuraTech 24", 36", 48", and 60" chimney pipe available with additional protective carton filler (CF) for shipping.

SIZE	5"		6"		7"		8"	
	ORDER #	STOCK #	ORDER #	STOCK #	ORDER #	STOCK #	ORDER #	STOCK #
A	5"		6"		7"		8"	
B	7"		8"		9"		10"	
LENGTH								
6" GA	--	--	6DT-06	810000067	7DT-06	810000141	8DT-06	810000209
6" BLACK	5DT-06B	810000055	6DT-06B	810000068	7DT-06B	810000142	8DT-06B	810000210
6" SS	5DT-06SS	810000001	6DT-06SS	810000069	7DT-06SS	810000143	8DT-06SS	810000211
9" GA	--	--	6DT-09	810000070	7DT-09	810000144	8DT-09	810000212
9" BLACK	5DT-09B	810000002	6DT-09B	810000071	7DT-09B	810000145	8DT-09B	810000213
9" SS	5DT-09SS	810000003	6DT-09SS	810000072	7DT-09SS	810000146	8DT-09SS	810000214
12" GA	--	--	6DT-12	810000073	7DT-12	810000147	8DT-12	810000215
12" BLACK	5DT-12B	810000004	6DT-12B	810000074	7DT-12B	810000148	8DT-12B	810000216
12" SS	5DT-12SS	810000005	6DT-12SS	810000075	7DT-12SS	810000149	8DT-12SS	810000217
18" GA	--	--	6DT-18	810000076	7DT-18	810000150	8DT-18	810000218
18" SS	5DT-18SS	810000006	6DT-18SS	810000077	7DT-18SS	810000151	8DT-18SS	810000219
24" GA	--	--	6DT-24	810000078	7DT-24	810000152	8DT-24	810000220
24" GA	--	--	6DT-24CF	810000079	7DT-24CF	810000153	8DT-24CF	810000221
24" SS	5DT-24SS	810000008	6DT-24SS	810000080	7DT-24SS	810000154	8DT-24SS	810000222
24" SS	5DT-24SSCF	810000009	6DT-24SSCF	810000081	7DT-24SSCF	810000155	8DT-24SSCF	810000223
36" GA	--	--	6DT-36	810000082	7DT-36	810000156	8DT-36	810000224
36" GA	--	--	6DT-36CF	810000083	7DT-36CF	810000157	8DT-36CF	810000225
36" SS	5DT-36SS	810000010	6DT-36SS	810000084	7DT-36SS	810000158	8DT-36SS	810000226
36" SS	5DT-36SSCF	810000011	6DT-36SSCF	810000085	7DT-36SSCF	810000159	8DT-36SSCF	810000227
48" GA	--	--	6DT-48	810000086	7DT-48	810000160	8DT-48	810000228
48" GA	--	--	6DT-48CF	810000087	7DT-48CF	810000161	8DT-48CF	810000229
48" SS	5DT-48SS	810000012	6DT-48SS	810000088	7DT-48SS	810000162	8DT-48SS	810000230
48" SS	5DT-48SSCF	810000013	6DT-48SSCF	810000089	7DT-48SSCF	810000163	8DT-48SSCF	810000231
60" GA	--	--	6DT-60CF	810000090	7DT-60CF	810000164	8DT-60CF	810000232
60" SS	5DT-60SSCF	810000014	6DT-60SSCF	810000091	7DT-60SSCF	810000165	8DT-60SSCF	810000233

Adjustable Pipe

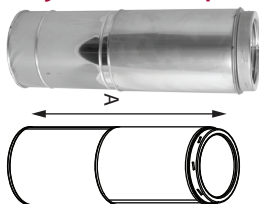

Use to add length to DuraTech chimney. Adjusts from 14"-21".

SIZE	6"	8"
A	14"-21"	
ORDER #	6DT-21TASS	8DT-21TASS
STOCK #	810000092	810000234

Elbow Kit

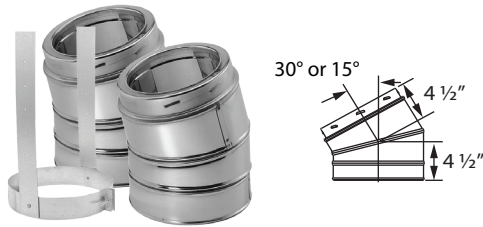

Elbow Kit includes: 2 Elbows and 1 Elbow Strap. Use for offsets around obstructions such as rafters, ridgepoles, or joists. May have two pairs of elbows, if needed. Offsets greater than 30° are not permitted in accordance to UL 103 standards. Elbows swivel 360° at base (angles are not adjustable). A pair of elbows is required to return an offset chimney back to vertical. Available in stainless steel (5"-8" SS) or galvalume (6"-8" GA) outer wall.

		15°	5"	6"	7"	8"			30°	5"	6"	7"	8"
GA	ORDER #	--		6DT-E15K	7DT-E15K	8DT-E15K	GA	ORDER #	--		6DT-E30K	7DT-E30K	8DT-E30K
	STOCK #	--		810000093	810000166	810000235		STOCK #	--		810000095	810000168	810000237
SS	ORDER #	5DT-E15KSS	6DT-E15KSS	7DT-E15KSS	8DT-E15KSS		SS	ORDER #	5DT-E30KSS	6DT-E30KSS	7DT-E30KSS	8DT-E30KSS	
	STOCK #	810000015	810000094	810000167	810000236			STOCK #	810000016	810000096	810000169	810000238	

Elbow Offset Chart For 5"-8" DuraTech

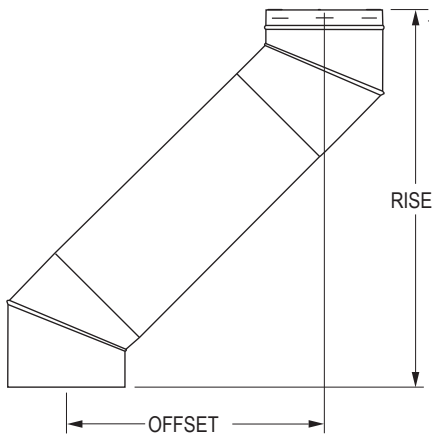

SIZE		5", 6", 7", 8" Diameter	
Elbow Angle from Vertical	Chimney Length Between Elbows	Offset inches	Rise inches
15°	0"	2"	16 1/2"
15°	6"	3 1/4"	21 1/4"
15°	9"	4"	24 1/8"
15°	12"	4 3/4"	27"
15°	18"	6 1/4"	32 3/4"
15°	24"	8"	38 1/2"
15°	36"	11"	50 1/4"
15°	48"	14 1/4"	61 3/4"
15°	48" + 6"	15 1/2"	66 1/2"
15°	48" + 9"	16 1/4"	69 3/8"
15°	48" + 12"	17"	72 1/4"
15°	48" + 18"	18 1/2"	78"
15°	48" + 24"	20"	83 3/4"
30°	0"	4"	15 3/4"
30°	6"	6 1/4"	20"
30°	9"	7 3/4"	22 5/8"
30°	12"	9 1/4"	25 1/4"
30°	18"	12 1/4"	30 1/4"
30°	24"	15 1/4"	35 1/2"
30°	36"	21 1/4"	46"
30°	48"	27 1/4"	56 1/4"
30°	48" + 6"	29 3/4"	60 1/2"
30°	48" + 9"	31 1/4"	63 1/8"
30°	48" + 12"	32 3/4"	65 3/4"
30°	48" + 18"	35 3/4"	71"
30°	48" + 24"	38 3/4"	76"

Adjustable Elbow Strap

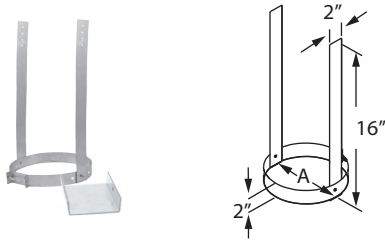

Use to prevent excessive weight on the elbows by supporting the weight of the chimney. Required to be installed between two elbows in offset installations. Multiple elbow straps may be required for offset installations. Refer to installation instructions.

SIZE	5" & 7"	6" & 8"
A	7", 9"	8", 10"
ORDER #	5DT-AES	6DT-AES
STOCK #	810007985	810007986

Square Ceiling Support Box

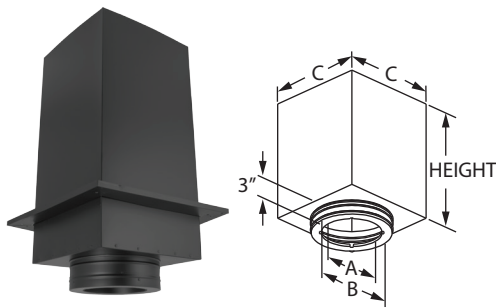

Supports chimney pipe and provides a positive connection between support box and chimney with a built-in twist-lock. Suitable for both flat and cathedral (A-Frame) ceiling applications. Also use in short attic spaces (see instructions). Fits between standard 16" on-center joists and most manufactured home applications. Supports up to 60' of DuraTech Chimney. Use adapter to attach DVL or DuraBlack to the support box. A 2" wide trim collar is included. Painted black. (For adapters see DVL/DuraBlack section.)

CEILING PITCH		
DURABLACK	DVL	USE
0/12 - 4/12	0/12 - 6/12	11" Support box
5/12 - 9/12	7/12 - 13/12	24" Support box
10/12 - 14/12	14/12 - 20/12	36" Support box

SIZE	5"	6"	7"	8"	
A	5 1/4"	6 1/4"	7 1/4"	8 1/4"	
B	9"	9"	11"	11"	
C	11"	12"	13"	14 1/4"	
HEIGHT					
11"	ORDER #	5DT-CS11	6DT-CS11	7DT-CS11	8DT-CS11
	STOCK #	810000018	810000098	810000171	810000240
24"	ORDER #	5DT-CS24	6DT-CS24	7DT-CS24	8DT-CS24
	STOCK #	810000019	810000099	810000172	810000241
36"	ORDER #	5DT-CS36	6DT-CS36	7DT-CS36	8DT-CS36
	STOCK #	810000020	810000100	810000173	810000242

Reduced Clearance Square Ceiling Support Box

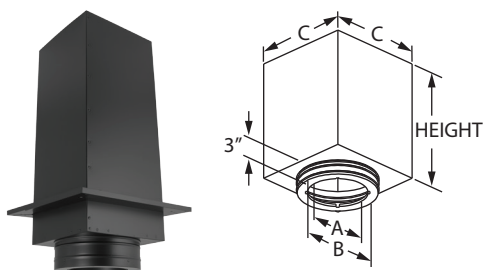

Supports chimney pipe and provides a positive connection between support box and chimney with a built-in twist-lock. Suitable for both flat and cathedral (A-Frame) ceiling applications. Also use in short attic spaces (see instructions). Fits between standard 12" on center joists and most manufactured home applications. Supports up to 60' of DuraTech Chimney. Use adapter to attach DVL or DuraBlack to the support box. A 2" wide trim collar is included. Painted black. (For adapters see DVL/DuraBlack section).

SIZE		6"
A		6 1/4"
B		9"
C		10"
HEIGHT		
24"	ORDER #	6DT-CS24R
	STOCK #	810000101

Square Ceiling Support Box w/ Collar

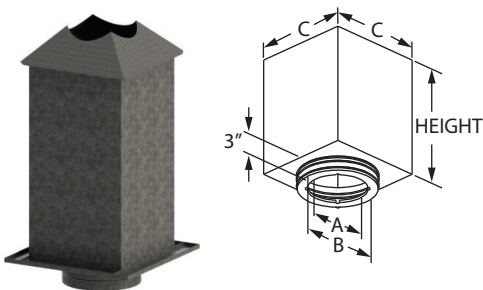

Use with flat, vaulted or cathedral ceilings where there is an attic space above. Supports up to 40' of DuraTech Chimney. The additional Insulation Collar now enables the support box to be qualified as an Attic Insulation Shield. The additional Attic Insulation Shield (DT-AIS) is not required with these support boxes.

SIZE		6"
A		6 1/4"
B		9"
C		12"
HEIGHT		
24"	ORDER #	6DT-CS24IS
	STOCK #	810009648
36"	ORDER #	6DT-CS36IS
	STOCK #	810009649

Round Ceiling Support Box

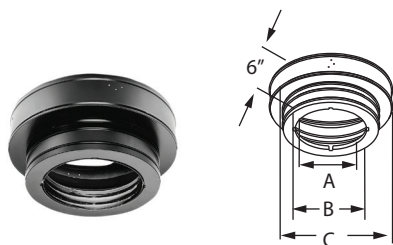

Supports chimney pipe and provides a positive connection between support box and chimney with a built-in twist-lock. Supports up to 60' of DuraTech Chimney. Use adapter to attach DVL or DuraBlack to the support box. Painted black. Trim collars are sold separately. (For adapters see DVL/DuraBlack section).

SIZE	5"	6"	7"	8"
A	5 1/4"	6 1/4"	7 1/4"	8 1/4"
B	9"	9"	11"	11"
C	11"	12"	13"	14"
ORDER #	5DT-RCS	6DT-RCS	7DT-RCS	8DT-RCS
STOCK #	810000021	810000102	810000174	810000243

Trim Collar for Round Support Box

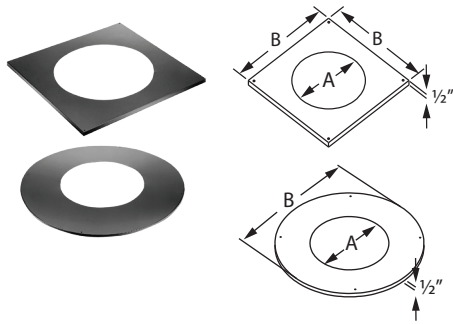

Conceals the gap between the Round Ceiling Support Box and the ceiling cutout. Select square or round. Painted black.

SQUARE TRIM COLLAR			ROUND TRIM COLLAR		
SIZE	5" - 6"	7" - 8"	SIZE	5" - 6"	7" - 8"
A	9 1/8"	11 1/8"	A	9 1/8"	11 1/8"
B	14"	16"	B	17 1/2"	21"
ORDER #	5DT-TC	7DT-TC	ORDER #	5DT-TCR	7DT-TCR
STOCK #	810000022	810000175	STOCK #	810000023	810000176

Flat Ceiling Support Box

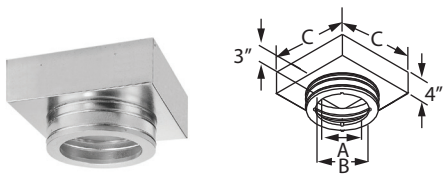

Supports chimney pipe and provides a positive connection between support box and chimney with a built-in twist-lock. Designed for installation in flat ceilings only. Supports up to 60' of DuraTech Chimney. Use adapter to attach DVL or DuraBlack to the support box. A 2" wide trim collar is included. Not painted, but can be painted with high temperature paint. (For adapters see DVL/DuraBlack section).

SIZE	5"	6"	7"	8"
A	5 1/4"	6 1/4"	7 1/4"	8 1/4"
B	9"	9"	11"	11"
C	11"	12"	13"	14 1/4"
ORDER #	5DT-FCS	6DT-FCS	7DT-FCS	8DT-FCS
STOCK #	810000024	810000103	810000177	810000244

Adjustable Roof Support

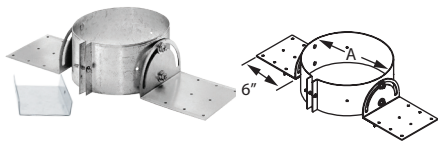

Designed to support the DuraTech Chimney and allows the chimney to pass through the roof and extend down the ceiling. Ideal for cathedral ceilings and free-standing appliance installations. Supports a maximum total chimney length of 45' above and 20' chimney below Roof Support. Adjustable to different roof pitches.

SIZE	5" & 7"	6" & 8"
A	7", 9"	8", 10"
ORDER #	5DT-ARS	6DT-ARS
STOCK #	810007991	810007992

Trim Collar for Roof Support

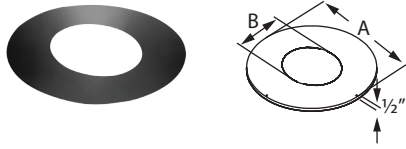

Conceals gap between chimney pipe and ceiling cut out when used with Roof Support. Galvalume. Painted black.

SIZE		5"	6"	7"	8"
A		18"	18"	20"	20"
B		7 1/4"	8 1/4"	9 1/4"	10 1/4"
0/12 - 3/12	ORDER #	5DT-RSTC3	6DT-RSTC3	7DT-RSTC3	8DT-RSTC3
	STOCK #	810000026	810000105	810000179	810000246
4/12 - 6/12	ORDER #	5DT-RSTC6	6DT-RSTC6	7DT-RSTC6	8DT-RSTC6
	STOCK #	810000027	810000106	810000180	810000247
7/12 - 9/12	ORDER #	5DT-RSTC9	6DT-RSTC9	7DT-RSTC9	8DT-RSTC9
	STOCK #	810000028	810000107	810000181	810000248
10/12 - 12/12	ORDER #	5DT-RSTC12	6DT-RSTC12	7DT-RSTC12	8DT-RSTC12
	STOCK #	810000029	810000108	810000182	810000249

Support Box Rails



Attach to outside of Square Ceiling Support Box to provide level, temporary support. Enables installer to easily fasten the box in place without the need for another pair of hands.

SIZE	6"
ORDER #	6DT-SBRU
STOCK #	810007036

Wall Thimble

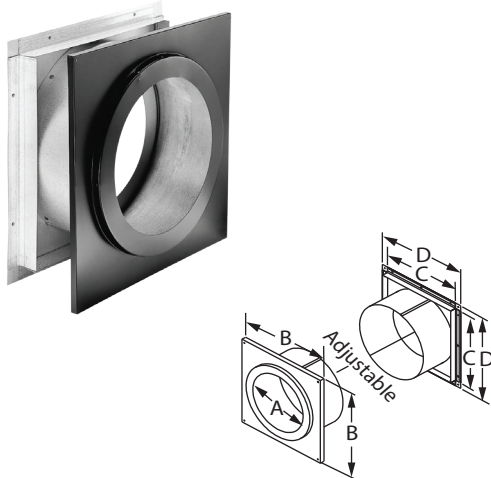

Adjusts from a minimum of 5 1/2" to a maximum of 9 1/2" wall thickness, and fits between standard wall studs. To accommodate thicker walls, the telescoping pieces can be extended up to 16" with a field-fabricated extension installed. Interior trim ring painted black. Must be installed with DuraTech chimney pipe horizontally through the wall and extend 6" into the room beyond the interior wall. (Black painted DuraTech is available). 6" and 8" stainless steel exterior trim available.

SIZE	5"	6"	7"	8"
A	7 1/8"	8 1/8"	9 1/8"	10 1/8"
B	14"	14"	16"	16"
C	10 7/8"	11 7/8"	12 7/8"	13 7/8"
D	13"	14"	15"	16"
ORDER #	5DT-WT	6DT-WT	7DT-WT	8DT-WT
STOCK #	810000030	810000109	810000183	810000250
SS TRIM	5"	6"	7"	8"
ORDER #	--	6DT-WTSS	--	8DT-WTSS
STOCK #	--	810000110	--	810000251

Tee w/ Cap

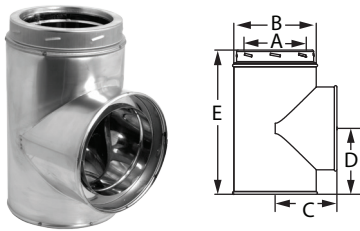

Use for through-the-wall installations. Includes removable tee cap for easy chimney cleaning or inspection. Wall Straps, a Wall Thimble, and an Adjustable Tee Support Bracket must be installed with the Tee as directed. Available in stainless steel or with a galvalume outer wall and stainless steel inner wall. See installation instructions for proper location and installation of Tee.

SIZE		5"	6"	7"	8"
A		5"	6"	7"	8"
B		7"	8"	9"	10"
C		5 1/2"	6 1/8"	6 1/2"	7 1/8"
D		6"	6 1/2"	7 1/2"	7 3/4"
E		12 5/8"	13 7/8"	14 1/4"	15 1/4"
GA	ORDER #	--	6DT-ST	7DT-ST	8DT-ST
	STOCK #	--	810000113	810000186	810000254
SS	ORDER #	5DT-STSS	6DT-STSS	7DT-STSS	8DT-STSS
	STOCK #	810000036	810000114	810000187	810000255

Adjustable Tee Support Bracket

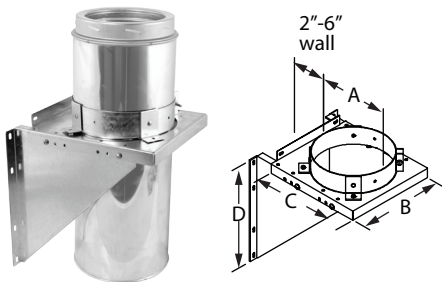

Use as wall support for chimney system. Use of straps is optional. Supports up to 50' of DuraTech Chimney without straps, and 70' of DuraTech Chimney with straps. Attaches to chimney pipe. Can be installed above or below the Tee. If installed below the Tee, a short section of pipe is required. Adjustable base provides 2" to 6" clearance to wall.

SIZE		5"	6"	7"	8"
A		7"	8"	9"	10"
B		10"	10"	12"	12"
C		11"	11"	13"	13"
D		11 3/4"	11 3/4"	13 3/4"	13 3/4"
GA	ORDER #	5DT-TSB	6DT-TSB	7DT-TSB	8DT-TSB
	STOCK #	810000033	810000111	810000184	810000252
SS	ORDER #	5DT-TSBSS	6DT-TSBSS	7DT-TSBSS	8DT-TSBSS
	STOCK #	810000034	810000112	810000185	810000253

Wall Strap

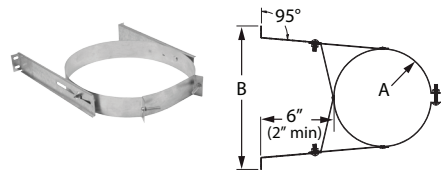

Use in interior or exterior installations to add lateral support to the chimney. Assures a 2" to 6" clearance to combustible walls. Required every 8'.

SIZE		6"	8"
A		8"	10"
B		11 3/4"	14"
GA	ORDER #	6DT-WS	8DT-WS
	STOCK #	810000137	810000278
SS	ORDER #	6DT-WSSS	8DT-WSSS
	STOCK #	810000138	810000279

Adjustable Wall Strap

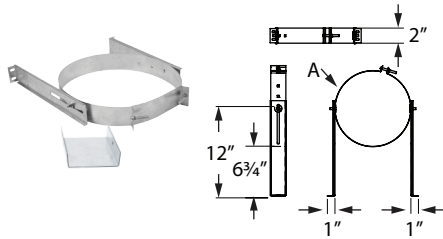

Stabilizes chimney while ensuring a minimum 2" clearance to combustibles. Can adjust out to 6" clearance if needed. One part covers 2 diameters (5" & 7" or 6" & 8").

SIZE		5" & 7"	6" & 8"
A		7", 9"	8", 10"
GA	ORDER #	5DT-AWS	6DT-AWS
	STOCK #	810007987	810007988
SS	ORDER #	5DT-AWS-SS	6DT-AWS-SS
	STOCK #	810008010	810008012

Adjustable Re-Support Bracket

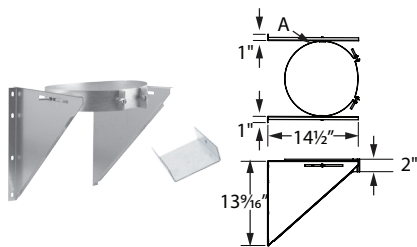

Supports up to 20' of DuraTech chimney. Can be installed above or below the tee. Adjustable base slides easily to provide between 2" and 6" of clearance to the wall. Can be used in place of tee support for chimneys under 20'. Or as an addition to tee support that goes beyond 50'.

SIZE	5" & 7"	6" & 8"
A	7", 9"	8", 10"
ORDER #	5DT-RES	6DT-RES
STOCK #	810007999	810008000

Adjustable Extended Wall Strap

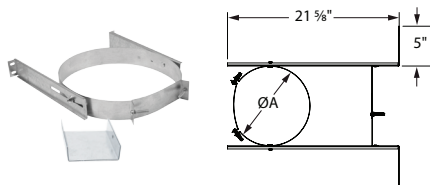

Stabilizes chimney while ensuring a minimum 2" clearance to combustibles. Can adjust out to 6" clearance if needed. One part covers 2 diameters (5" & 7" or 6" & 8"). For 5" diameter, it adjusts from 8 1/2" to 15 1/2". For 6" diameter, it adjusts from 8" to 15". For 7" diameter, it adjusts from 7 1/2" to 14 1/2". For 8" diameter, it adjusts from 7" to 14". Also available in Stainless Steel (SS). Requires a wall strap to be used every 8' to keep the chimney aligned and spaced properly throughout the installation.

SIZE		5" & 7"	6" & 8"
A		7", 9"	8", 10"
GA	ORDER #	5DT-AWSX	6DT-AWSX
	STOCK #	810009651	810009652
SS	ORDER #	5DT-AWSX-SS	6DT-AWSX-SS
	STOCK #	810009960	810009961

Adjustable Extended Wall Support

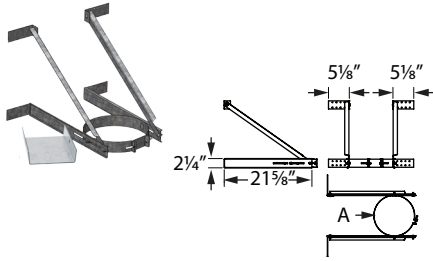

Use above the tee to provide support when bypassing obstructions or overhangs. Supports up to 20' of chimney. Tee Support is not necessary when using this support. For 5" diameter, it adjusts from 8 1/2" to 15 1/2". For 6" diameter, it adjusts from 8" to 15". For 7" diameter, it adjusts from 7 1/2" to 14 1/2". For 8" diameter, it adjusts from 7" to 14". Also available in Stainless Steel (SS).

SIZE	5" & 7"	5" & 7" (SS)	6" & 8"	6" & 8" (SS)
A	7", 9"	7", 9"	8", 10"	8", 10"
ORDER #	5DT-XWS	5DT-XWS-SS	6DT-XWS	6DT-XWS-SS
STOCK #	810007997	810009962	810007998	810009963

Finishing Collar w/ Adapter

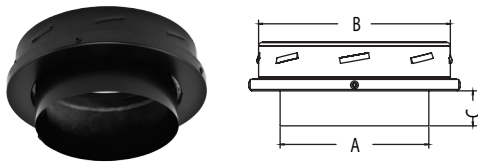

New integrated collar with adapter, fits into the female end of the chimney pipe to provide a decorative black finish. Use on chimney pipe that is suspended with the roof support system or on pipe that is passing through a wall thimble. Provides proper connection to DVL or DuraBlack. No other adapter is needed.

SIZE	5"	6"	7"	8"
A	5"	6"	7"	8"
B	6 1/2"	7 1/2"	8 1/2"	9 1/2"
C	1 1/4"	1 1/8"	1 1/8"	1 1/8"
ORDER #	5DT-FC	6DT-FC	7DT-FC	8DT-FC
STOCK #	810000037	810000115	810000188	810000256

Anchor Plate

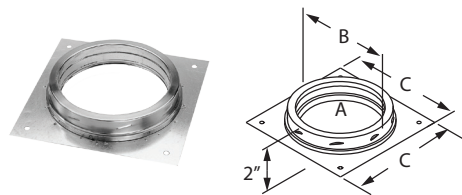

Use to attach DuraTech Chimney to an appliance or masonry fireplace. Check with appliance manufacturer to ensure DuraTech Chimney is approved for use.

SIZE	5"	6"	7"	8"
A	5"	6"	7"	8"
B	7"	8"	9"	10"
C	9"	10"	11"	12"
ORDER #	5DT-AP	6DT-AP	7DT-AP	8DT-AP
STOCK #	810000038	810000116	810000189	810000257

Transition Anchor Plate

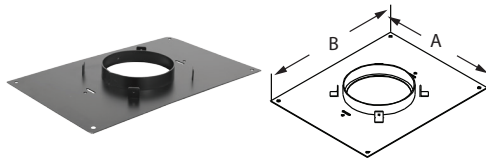

Use when converting from DuraLiner to DuraTech in chimney restoration. Use with a DuraLiner Slip Connector and Hanger.

SIZE	6"	6"	6"	6"
A	14"	17"	13"	17"
B	17"	17"	21"	21"
ORDER #	6DT-AP14x17	6DT-AP17x17	6DT-AP13x21	6DT-AP17x21
STOCK #	810000117	810000118	810000119	810000120
SIZE	8"	8"	8"	8"
A	14"	17"	13"	17"
B	17"	17"	21"	21"
ORDER #	8DT-AP14x17	8DT-AP17x17	8DT-AP13x21	8DT-AP17x21
STOCK #	810000258	810000259	810000260	810000261

Firestop Radiation Shield

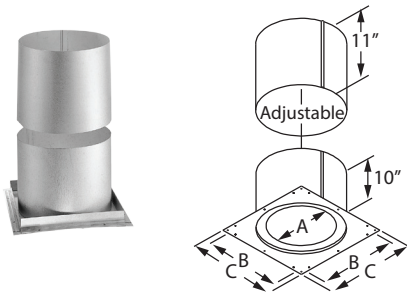

Use in ceiling/floor penetrations when a ceiling support is not used. Not required when passing through the roof. Fits on underside of ceiling and adjusts to cover framing.

SIZE	5"	6"	7"	8"
A	7 1/8"	8 3/8"	9 3/8"	10 1/8"
B	10 7/8"	11 7/8"	12 7/8"	13 7/8"
C	13"	14"	15"	16"
ORDER #	5DT-FRS	6DT-FRS	7DT-FRS	8DT-FRS
STOCK #	810000039	810000121	810000190	810000262

Attic Insulation Shield

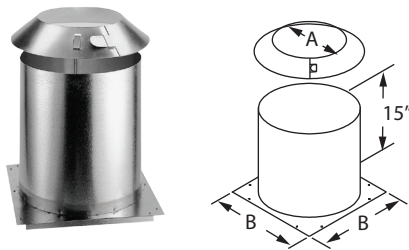

Required for installations that pass through an attic to prevent insulation and debris from accumulating near the chimney. Fits over Firestop Radiation Shield or a support box. Consists of two parts – a collar and a base.

SIZE	5"	6"	7"	8"
A	7"	8"	9"	10"
B	13"	14"	15"	16"
ORDER #	5DT-IS	6DT-IS	7DT-IS	8DT-IS
STOCK #	810000040	810000122	810000191	810000263

Roof Radiation Shield

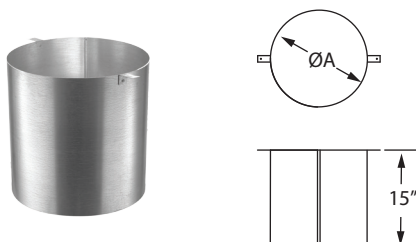

Install where a chimney passes through a roof. May be required for Canadian zero-clearance fireplaces, refer to appliance manufacturer's installation instructions.

SIZE	5"	6"	7"	8"
A	9"	10"	11"	12"
ORDER #	5DT-RRS	6DT-RRS	7DT-RRS	8DT-RRS
STOCK #	810000041	810000123	810000192	810000264

Chase Top Flashing

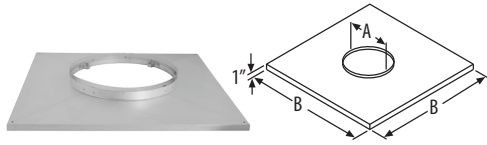

Encloses the top of a chase while providing a ventilation air passage from the chase. UL Listed. Includes spacer clips. Storm collar not included. Made of galvalume.

SIZE	5"	6"	7"	8"
A	10"	11"	12"	13"
B	18 3/4"	19 3/4"	20 3/4"	21 3/4"
ORDER #	5DT-CTF	6DT-CTF	7DT-CTF	8DT-CTF
STOCK #	810000042	810000124	810000193	810000265

Adjustable Extended Roof Bracket

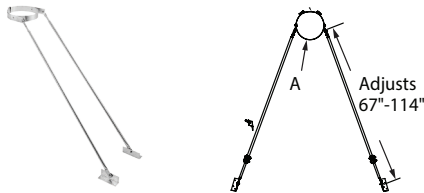

Extended roof bracket; provides additional support for the chimney when the chimney extends more than 5' beyond the roof; the legs will extend to handle varying roof slopes. New sandwich clamps allow legs to be extended to any length from 67" to 114". No drilling required.

SIZE	5" & 7"	6" & 8"
A	7", 9"	8", 10"
ORDER #	5DT-XRS	6DT-XRS
STOCK #	810007989	810007990

Locking Band



Use for extra security at pipe, elbow, and tee joints. Optional.

SIZE	5"	6"	7"	8"
A	7"	8"	9"	10"
ORDER #	5DT-LB	6DT-LB	7DT-LB	8DT-LB
STOCK #	810000051	810000136	810000204	810000277

Snow Splitter

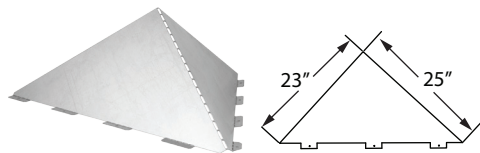

Three times thicker and stronger, allowing it to stand up against heavier snow loads. Bendable attachment flanges allow it to mount on any roof slope. Use to divert snow around chimney, vent and roof flashing. Constructed of paintable galvanized material. Ships flat for easy assembly. Works with 6", 7", 8", and 10".

SIZE	6"
ORDER #	6DT-SP
STOCK #	810007981

DSA Roof Flashings

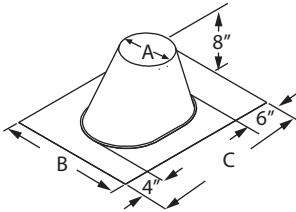
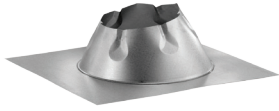

Use with metal or tile roofs. Available in sizes 6" and 8" in large base 0/12-6/12 (shown) and 7/12-12/12 styles. Made of dead soft aluminum. Refer to Roof Flashing table for dimensions.

STOCK #		6"	8"
0/12 - 6/12	A	9"	11"
	B	20"	30"
	C	27 3/16"	29 1/2"
	ORDER #	6DT-F6DSA	8DT-F6DSA
	STOCK #	810000127	810000268
7/12 - 12/12	A	9"	11"
	B	20"	24 1/4"
	C	30"	33 1/4"
	ORDER #	6DT-F12DSA	8DT-F12DSA
	STOCK #	810000129	810000270

Roof Flashing

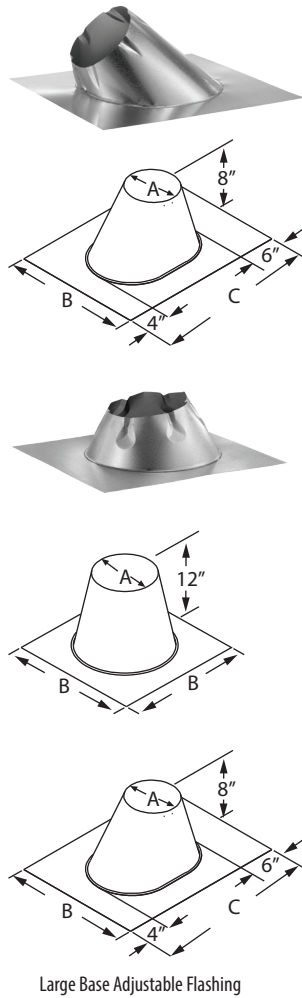

Use to weather proof the penetration of chimney pipe through the roof. Storm Collar required. Select roof flashing based on pitch of roof. For example, a 6/12 pitch has a vertical rise of 6" over a horizontal distance of 12". Made of galvalume. 6"-8" available with large base.

ADJUSTABLE SIZE		5"	6"	7"	8"
0/12 - 6/12	A	7 1/2"	8 1/2"	9 1/2"	10 1/2"
	B	19"	20"	21"	22"
	C	26"	27 3/16"	28 3/16"	29 1/2"
	ORDER #	5DT-F6	6DT-F6	7DT-F6	8DT-F6
	STOCK #	810000045	810000126	810000196	810000267
7/12 - 12/12	A	7 1/2"	8 1/2"	9 1/2"	10 1/2"
	B	19"	20"	21"	22"
	C	28 7/16"	30"	31 5/16"	33 1/4"
	ORDER #	5DT-F12	6DT-F12	7DT-F12	8DT-F12
	STOCK #	810000046	810000128	810000197	810000269
13/12 - 18/12	A	7 1/2"	8 1/2"	9 1/2"	10 1/2"
	B	19"	20"	21"	22"
	C	32 3/16"	34 3/8"	36 3/16"	38"
	ORDER #	5DT-F18	6DT-F18	7DT-F18	8DT-F18
	STOCK #	810000047	810000130	810000198	810000271
19/12 - 24/12	A	7 1/2"	8 1/2"	9 1/2"	10 1/2"
	B	19"	20"	21"	22"
	C	37 3/16"	39 1/2"	41 3/4"	44"
	ORDER #	5DT-F24	6DT-F24	7DT-F24	8DT-F24
	STOCK #	810000048	810000131	810000199	810000272
FLAT ROOF		5"	6"	7"	8"
	A	7 1/4"	8 1/4"	9 1/4"	10 1/4"
	B	19 1/16"	20 1/16"	21 5/8"	21 5/8"
	ORDER #	5DT-FF	6DT-FF	7DT-FF	8DT-FF
	STOCK #	810000049	810000132	810000200	810000273
	LRG BASE ADJUSTABLE SIZE		5"	6"	7"
0/12 - 6/12	A	--	8 1/4"	9 1/4"	10 1/4"
	B	--	28"	29"	30"
	C	--	27"	28"	29"
	ORDER #	--	6DT-F6L	7DT-F6L	8DT-F6L
	STOCK #	--	810000133	810000201	810000274
7/12 - 12/12	A	--	8 1/4"	9 1/4"	10 1/4"
	B	--	28"	29"	30"
	C	--	30"	31"	33"
	ORDER #	--	6DT-F12L	7DT-F12L	8DT-F12L
	STOCK #	--	810000134	810000202	810000275

Storm Collar

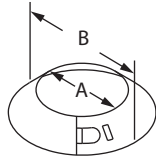

Required with DuraTech flashing to create a weather-proof penetration through the roof deck. Seal inner edge of the collar to the chimney pipe with non-hardening 500° F high-temperature sealant. Made of aluminum.

SIZE	5"-6"	7"-8"
A	7"-8"	9"-10"
B	12"-14"	15"-16"
ORDER #	5DT-SC	7DT-SC
STOCK #	810000043	810000194

Chimney Cap

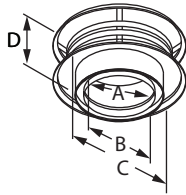

Required where pipe terminates above the roof line. Removable screws allow for cleaning of the chimney and spark arrestor screen. Made of stainless steel. See with optional Spark Arrestor screen below.

SIZE	5"	6"	7"	8"
A	5"	6"	7"	8"
B	7"	8"	9"	10"
C	11"	11"	15"	15"
D	6 1/2"	6 1/2"	6 1/2"	6 1/2"
ORDER #	5DT-VC	6DT-VC	7DT-VC	8DT-VC
STOCK #	810000050	810000135	810000203	810000276

Spark Arrestor

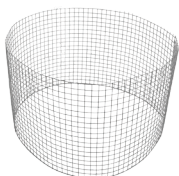

Use on inside of cap. Optional Spark Arrestor may be required.

SIZE	5" - 8"
ORDER #	5DT-SA
STOCK #	810000054

Chase Air Intake w/ Rodent Guard

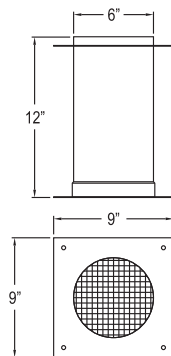
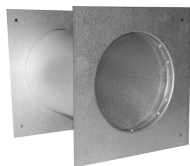

Allows required ventilation air into chase. Screen keeps rodents out.

SIZE	6"
ORDER #	6DT-CAI
STOCK #	810000502